

Article number: 03554035

Description: Fluro hydraulic rod end FMA 35D

Measures

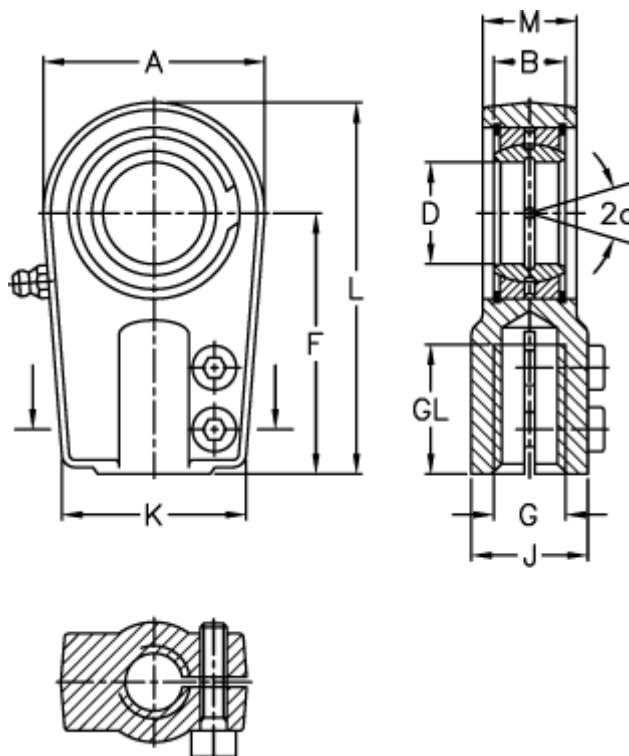

A	= 78	J	= 44
a (degrees)	= 7	K	= 66
B	= 25	L	= 132
D	= 35	M	= 30
Dynamic load C (kN)	= 112	Static load C0 (kN)	= 185
F	= 90	Torque (N m)	= 40
g	= M30x2	Weight	= 1300
GL	= 45		